

Programmable Operator Interface

# TECHNOSHOT

## Safety Considerations

- For safe operation, read the instruction manual or user manual that comes with the product carefully or consult the distributor from which you purchased the product, before using the product.
- Products introduced in this catalog have not been designed or manufactured for such applications in a system or equipment that will affect human bodies or lives.
- Customers, who want to use the products introduced in this catalog for special systems or devices such as for atomic-energy control, aerospace use, medical use, passenger vehicle, and traffic control, are requested to consult the Hakko Overseas Sales Section.
- Customers are requested to prepare safety measures when they apply the products introduced in this catalog to such systems or facilities that will affect human lives or cause severe damage to property if the products become faulty.
- For safe operation, wiring should be conducted only by qualified engineers who have sufficient technical knowledge about electrical work or wiring.

## Notes to consider before purchasing

- Appearance and specifications are subject to modification without prior notice due to technical improvements.
- Colors in the catalog may differ from the actual colors due to printing inaccuracies.
- Consult your distributor or us for further information about products in this catalog.

**www.monitouch.com**

### Hakko Electronics Co., Ltd.

Overseas Sales Department  
890-1 Kamikashiwano-machi,  
Hakusan, Ishikawa 924-0035, Japan

- Tel  
+81-76-274-2144
- Fax  
+81-76-274-5136
- E-mail  
sales@hakko-elec.co.jp

Distributor

\* Product specifications and design are subject to modification.  
\* Combined images are used for the screen images.  
\* Product colors may differ from colors in brochure photos due to printing.  
\* Windows and Excel are trademarks of Microsoft (USA) in the U.S. and other countries.  
\* Other company and product names in this brochure are registered trademarks.  
\* Printed with environment-friendly soy ink.



16080050000

9047NE0

Quick and accurate machine data at your fingertips



Hakko Electronics Co., Ltd.

# The functions that meet the needs of production sites

# support the development of speedy production systems.



TS2060



TS2060i



\* DUR-00 and CUR-xx can be attached.

	TS2060	TS2060i	
Screen memory (FROM)	2.5M bytes	10.5M bytes	
Backup memory (SRAM)	128K bytes	512K bytes	
Stroke font	-	Compatible	
Screen specifications	Display device	TFT color	
	Resolution	320 × 240 dots	
	Display size	5.7 inches (QVGA)	
	Colors	65,536 colors(The software is compatible with displays in 32K colors, 256 colors, 128 colors and monochrome.)	
Backlight	Backlight	LED	
	Backlight life	50,000 hrs	
Touch switch	Type	Analog resistive film	
Function switch	Number of switches	6	
External interface	D-Sub 9-pin <sup>1</sup>	RS-232C/RS-422/RS-485, asynchronous type, Data length: 7, 8 bits, Parity: odd, even, none, Stop bit: 1, 2 bits, Baud rate: 4800, 9600, 19200, 38400, 57600, 76800, 115200 bps	
	Modular 8-pin (MJ1/2)	RS-232C/RS-422(4-wire type) <sup>2</sup> /RS-485 (2-wire type), asynchronous type, Data length: 7, 8 bits, Parity: odd, even, none, Stop bit: 1, 2 bits, Baud rate: 4800, 9600, 19200, 38400, 57600, 76800, 115200, 187500 bps <sup>3</sup>	
	SD card	-	1 card slot(SD/SDHC card)
	Ethernet	-	1CH, Baud rate: 100Mbps, 10Mbps
USB	Type mini-B(Ver. 2.0)	Type A, Type mini-B(Ver. 2.0)	
Communication unit	-	CUR-xx compatible	
Power supply	Permissible range of voltage	DC24 V ± 10%	
	Demand(maximum rating)	13W or lower	
Physical environment	Ambient temperature	0°C ~ +50°C <sup>4</sup>	
	Ambient storage temperature	-10°C ~ +60°C <sup>4</sup>	
	Ambient humidity	85% RH or less (without dew condensation)	
	Storage humidity	85% RH or less (without dew condensation)	
	Operation altitude	2,000 meters or less	
	Operation atmosphere	Not exposed to corrosive gas or excessive dust (free of conductive dust)	
	Contamination level	Level 2	
Installation conditions	Grounding resistance	Less than 100 Ω, FG/SG separation	
	Protect structure	Front panel: Compatible with IP65 (when gasket is used), Rear cover: Compatible with IP20	
	Cooling system	Natural air cooling	
	Dimensions W×H×D	182.5 × 138.8 × 45.8 mm	
Panel cutout	174.0 <sup>+0.5</sup> × 131.0 <sup>+0.5</sup> mm(Same as for V806/V606e/S806)		
Compatible standards	CE/KC/UL61010-1, UL61010-2-201		
Case color	Black		
Battery	Built-in button battery / Battery life: 5 years (ambient temperature 25°C)		

<sup>1</sup> Only when an optional unit DUR-00 is attached to TS2060i. <sup>2</sup> Only MJ2 is compatible with 4-wire system. <sup>3</sup> SIEMENS MPI / PPI at 187500 bps is available only with MJ2. <sup>4</sup> Keep wet bulb temperature under 39°C to avoid malfunction.

## Connection and data transmission with multiple devices are possible.

### 8-way Communication

One TS unit can connect up to eight types of PLC and peripherals of different models and manufacturers via Ethernet (8 protocols) and serial connection (3 protocols).

### Gateway Function (Transmission Table)

Data of multiple units can be read and written by means of the Transmission Table.

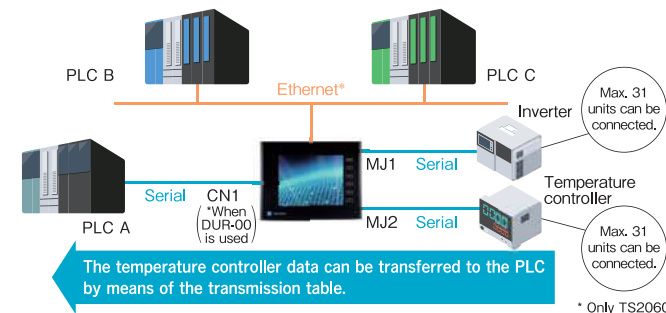

## Use of SD Cards for Greater Convenience (TS2060i only)

### Sampling Function

Sampling data of the PLC and temperature controller are shown on trend graphs, and saved as CSV files in the SD card.



### Recipe Function

Production conditions and parameters are saved as CSV files in the SD card, and read into the PLC when necessary.



### Screen Data Transmission

Screen data is saved in the SD card and transferred without using a PC.

## Functions that Improve Convenience and Safety

### Multilanguage

You can change the language displayed on the screen to one of 16 languages. You do not need to manage files for each language.



Compatible language fonts	Japanese, English/ Western European, Chinese (traditional and simplified), Korean, Central European, Cyrillic, Greek, Turkish and Baltic (Other languages can be displayed by using Windows fonts.)
---------------------------	---

### Security Function

By setting a function limit according to the user level, a high-security environment can be established.



### Operation Log\*

You can view log data for operations such as pushing of buttons and entering of values to analyze the causes of failure.

\* Only TS2060i.

## Expansion of connectivity by means of USB ports

### USB Port (Compatible with USB Ver.2.0)

The unit comes with USB ports. Various devices can be connected using Type A\* and Type mini-B ports.

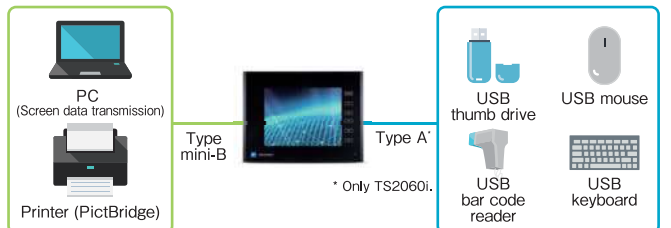

### Path-through Programming

PLC program data can be transferred via the USB slave port. There is no need for cable insertion and removal.



## Versatile Network Functions for Increasing Production Efficiency

### FTP Server Function

Data stored in an SD card of TS2060i in a remote place can be read out and modified.

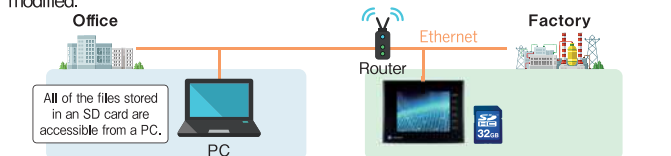

### MES Incorporated

Various kinds of information such as production quantity, number of defective products and cause of production stoppage are sent in SQL from TS2060i to the database via V-Server. No program is needed for communication with the database. (MES: Manufacturing Execution System)

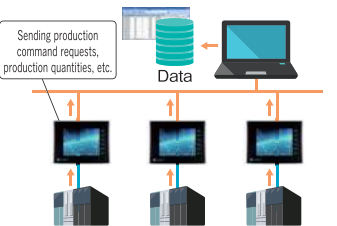

## A Product Line that Meets a Wide Variety of Needs

### Special Models

Special models of the TS2000 series are available according to customer needs.

Model	Specifications
TS2060□-U003	Without function switches and Fe-MONITOUCH logo
TS2060□-U150	Without Fe-MONITOUCH logo
TS2060□-004	Sulfidizing-gas resistant

\*Please ask our sales department about the delivery period and price.

### Vertical Installation

Vertical screen layout (90° rotation) is available for display and editing. The viewing angle is 80° and it is easy to see the screen even when it is installed vertically.



TS2060□ TS2060□-U003

## Dimensions and Part Names

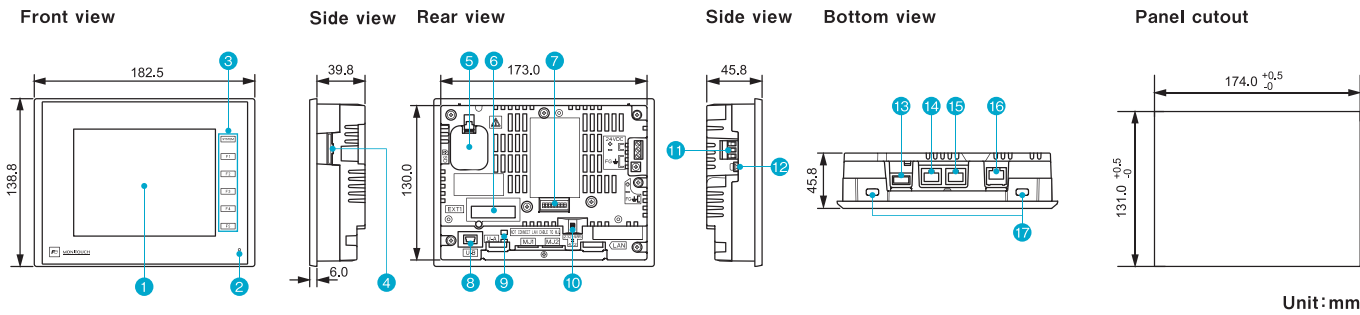

Unit:mm

### Part Names

- |  |                             |  |
|--|-----------------------------|--|
| ① Display  | ⑦ DIP switch                | ⑬ USB-A (U-A)*                         |
| ② Power lamp                                     | ⑧ USB mini-B (U-B)          | ⑭ Modular jack (MJ1)                   |
| ③ Function switches                              | ⑨ USB cable fixing hole     | ⑮ Modular jack (MJ2)                   |
| ④ SD card connector (SD)*                        | ⑩ Slide switch              | ⑯ 100BASE-TX/10BASE-T connector (LAN)* |
| ⑤ Battery holder                                 | ⑪ Terminal block            | ⑰ Screw hole                           |
| ⑥ Communication interface unit connector (EXT1)* | ⑫ Communication FG terminal |  |

\* Only TS2060i.

## Model Designation

TS2060i  
 TS2060

- i : Optional unit DUR-00 and CUR-xx can be attached.  
 SD/SDHC slot: 1CH  
 Ethernet: 1CH  
 USB Type A: 1 port  
 External 5V power supply available
- None : No above external interfaces  
 External 5V power supply not available

## Interface

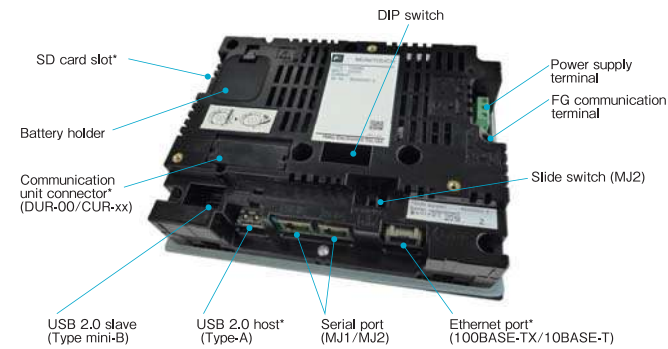

\* Only TS2060i.

## System Configuration

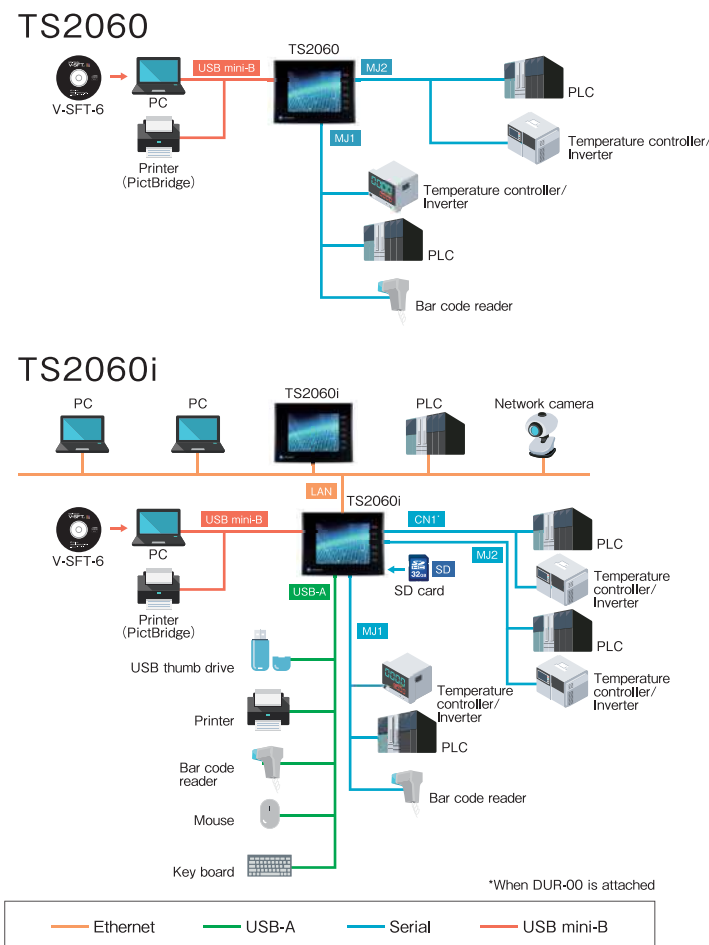

## Optional Units

- V-SFT-6** (Configuration software)  
 Compatible OS: Windows XP / XP 64 Edition / Vista (32bit,64bit) / Win7 (32bit,64bit) / Win8 (32bit,64bit) / Win8.1 (32bit,64bit) / Win10 (32bit,64bit)
- TC-D9** (Terminal Converter)\*  
 RS-422/485 terminal converter to connect DUR-00 and a communication unit
- UA-FR** (USB-A port cable)\*  
 Cable to connect to the USB-A (master) port
- V906T-GS, V906T-GSN10**  
 Protection sheet (5 sheets)  
 Non-glare type (V906T-GSN10) is available.
- TS-BT** (Battery)  
 Lithium battery for TS2000 series
- DUR-00** (Optional unit)\*  
 For attaching a Dsub9 pin
- CUR-xx** (Communication interface units)\*  
 Communication units for connecting with networks.  
 CUR-00 : OPCN-1    CUR-04 : PROFIBUS-DP  
 CUR-01 : T link    CUR-06 : SX bus  
 CUR-02 : CC-Link    CUR-07 : DeviceNet  
 CUR-03 : Ethernet    CUR-08 : FL-net

⚠ DUR-00 and CUR-xx cannot be used simultaneously.

\* Only TS2060i.

## PLC driver list

Maker	PLC
Allen-Bradley	PLC-5
	PLC-5 (Ethernet)
	SLC500
	SLC500 (Ethernet TCP/IP)
	NET-ENI (SLC500 Ethernet TCP/IP)
	NET-ENI (MicroLogix Ethernet TCP/IP)
	MicroLogix
	MicroLogix (Ethernet TCP/IP)
	ControlLogix / CompactLogix
	ControlLogix (Ethernet)
	Micro 800 Controllers
	Micro 800 Controllers (Ethernet TCP/IP)
	Direct LOGIC (K-Sequence)
Automationdirect	Direct LOGIC (Ethernet UDP/IP)
Direct LOGIC (MODBUS RTU)	
Azbil	MX series
Baumüller	BMx-x-PLC
Beckhoff	ADS Protocol (Ethernet)
CIMON	BP Series
	CP Series
	S Series
	S Series (Ethernet)
	DVP series
DELTA	DVP series
EATON Cutler-Hammer	ELC
EMERSON	EC10/EC20/EC20H (MODBUS RTU)
FANUC	Power Mate
FATEK AUTOMATION	FACON FB series
FUFENG	APC Series Controller
Fuji Electric	MICREX-F series
	MICREX-F series V4-compatible
	MICREX-F T-Link
	MICREX-F T-Link V4-compatible
	SPB (N mode) & FLEX-PC series
	SPB (N mode) & FLEX-PC CPU
	MICREX-SX (T-Link)
	MICREX-SX (OPCN-1)
	MICREX-SX (SX bus)
	MICREX-SX SPH/SPB/SPM/SPE series
	MICREX-SX SPH/SPB/SPM/SPE CPU
	MICREX-SX (Ethernet)
	90 series
90 series (SNP-X)	
90 series (SNP)	
90 series (Ethernet TCP/IP)	
RX3i (Ethernet TCP/IP)	
Hitachi	HIDIC-S10/2alpha, S10mini
	HIDIC-S10/2alpha, S10mini (Ethernet)
	HIDIC-S10/4alpha
	HIDIC-S10V
	HIDIC-S10V (Ethernet)
Hitach Industrial Equipment Systems	HIDIC-H
	HIDIC-H (Ethernet)
	HIDIC-EHV
	HIDIC-EHV (Ethernet)
HYUNDAI	Hi5 Robot (MODBUS RTU)
Hi4 Robot (MODBUS RTU)	
IDEC	MICRO3
	MICRO Smart
	MICRO Smart pentra
Jetter	JetControl Series2/3 (Ethernet UDP/IP)
JTEKT	TOYOPUC
	TOYOPUC (Ethernet)
	TOYOPUC (Ethernet PC10 mode)
	TOYOPUC-Plus
	TOYOPUC-Plus (Ethernet)
KEYENCE	KZ series link
	KZ-A500 CPU
	KZ/KV series CPU
	KZ24/300 CPU
	KV10/24 CPU
	KV-700
	KV-700 (Ethernet TCP/IP)
	KV-1000
KV-1000 (Ethernet TCP/IP)	
KV-3000/5000	
KV-3000/5000 (Ethernet TCP/IP)	
KV-7000 (Ethernet TCP/IP)	
KOYO ELECTRONICS	SU/SG

Maker	PLC	
KOYO ELECTRONICS	SR-T (K protocol)	
	SU/SG (K-Sequence)	
	SU/SG (MODBUS RTU)	
LS	MASTER-KxxxS	
	MASTER-KxxxS CNET	
	MASTER-K series (Ethernet)	
	GLOFA CNET	
	GLOFA GM7 CNET	
	GLOFA GM series CPU	
	GLOFA GM series (Ethernet UDP/IP)	
	XGT/XGK series CNET	
	XGT/XGK series CPU	
	XGT/XGK series (Ethernet)	
	XGT/XGI series CNET	
	XGT/XGI series CPU	
	XGT/XGI series (Ethernet)	
	MITSUBISHI ELECTRIC	A series link
		A series CPU
		A series (OPCN-1)
		QnA series link
QnA series CPU		
QnA series (Ethernet)		
QnH (Q) series link		
QnH (Q) series CPU		
QnH (Q) series (Ethernet)		
QnH (Q) series link (multi CPU)		
QnH (Q) series (multi CPU) (Ethernet)		
QnH (Q) series (Ethernet ASCII)		
QnH (Q) series (multi CPU) (Ethernet ASCII)		
QnU series (built-in Ethernet)		
L series link		
L series (built-in Ethernet)		
L series CPU		
A series (CC-LINK)		
QnA series (CC-LINK)		
QnH (Q) series (CC-LINK)		
FX series CPU		
FX2N/1N series CPU		
FX1S series CPU		
FX series link (A protocol)		
FX3U/3UC/3G series CPU		
FX3U/3GE series (Ethernet)		
FX3U/3UC/3G series link (A protocol)		
FX5U/5UC series		
FX5U/5UC series (Ethernet)		
Alink+Net10		
Q170MCP (multi CPU)		
Q170 series (multi CPU) (Ethernet)		
iQ-R series (built-in Ethernet)		
iQ-R series link		
iQ-R series (Ethernet)		
MODICON	MODBUS RTU	
MOELLER	PS4	
OMRON	SYSMAC C	
	SYSMAC C (OPCN-1)	
	SYSMAC CV	
	SYSMAC CS1/CJ1	
	SYSMAC CS1/CJ1 DNA	
	SYSMAC CS1/CJ1 (Ethernet)	
	SYSMAC CS1/CJ1 (Ethernet Auto)	
	SYSMAC CS1/CJ1 DNA (Ethernet)	
Panasonic	FP Series (RS232C/422)	
	FP Series (TCP/IP)	
	FP Series (UDP/IP)	
	FP-X (TCP/IP)	
	FP7 Series (RS232C/422)	
RS Automation	FP7 Series (Ethernet)	
	NX7/NX Plus Series (70P/700P/CCU+)	
N7/NX Series (70/700/750/CCU)		
SAIA	NX700 Series (Ethernet)	
	X8 Series	
	X8 Series (Ethernet)	
PCD	PCD	
	PCD S-BUS (Ethernet)	

PLC driver list

Maker	PLC
SAMSUNG	SPC series
	N_plus
	SECNET
SHARP	JW series
	JW100/70H COM port
	JW20 COM port
	JW series (Ethernet)
	JW300 series
	JW311/312/321/322 series (Ethernet)
	JW331/332/341/342/352/362 series (Ethernet)
SINFONIA TECHNOLOGY	SELMART
Siemens	S5 PG port
	S7
	S7-200 PPI
	S7-200 (Ethernet ISOTCP)
	S7-300/400MPI
	S7-300/400 (Ethernet ISOTCP)
	S7-300/400 (Ethernet TCP/IP PG protocol)
	S7-1200/1500 (Ethernet ISOTCP)
	S7 PROFIBUS-DP
	TI500/505
	TI500/505 V4 Compatible
TECO	TP03 (MODBUS RTU)
Telemecanique	TSX Micro
TOSHIBA	T series / V series (T compatible)
	T series / V series (T compatible) (Ethernet UDP/IP)
	EX series
TOSHIBA MACHINE	nv series (Ethernet UDP/IP)
	TC200
TOYO DENKI	μGPCsx (OPCN-1)
	μGPCsx (SX bus)
	μGPCsx series
	μGPCsx CPU
TURCK	μGPCsx series (Ethernet)
	BL Series Distributed I/O (MODBUS TCP/IP)
Ultra Instruments	UIC CPU (MODBUS ASCII)
UNITRONICS	M90/M91 /Vision Series (ASCII)
VIGOR	Vision Series (ASCII Ethernet TCP/IP)
VIGOR	M series
WAGO	750 series (MODBUS RTU)
	750 series (MODBUS Ethernet)
XINJE	XC Series (MODBUS RTU)
Yaskawa Electric	MEMOBUS
	CP9200SH/MP900
	MP2300(MODBUS TCP/IP)
	CP/MP EXPANSION MEMOBUS (UDP/IP)
	MP2000 series
	MP2000 series(UDP/IP)
	MP3000 series (Ethernet UDP/IP)
	MP3000 series EXPANSION MEMOBUS (Ethernet)
Yokogawa Electric	FA-M3
	FA-M3R
	FA-M3/FA-M3R (Ethernet UDP/IP)
	FA-M3/FA-M3R (Ethernet UDP/IP ASCII)
	FA-M3/FA-M3R (Ethernet TCP/IP)
	FA-M3/FA-M3R (Ethernet TCP/IP ASCII)
	FA-M3V
	FA-M3V (Ethernet )
FA-M3V (Ethernet ASCII)	
Others	Universal Serial
	FL-Net
	PROFIBUS-DP
	DeviceNet
	Without PLC connection
	MODBUS RTU
	MODBUS RTU EXT Format
	MODBUS TCP/IP (Ethernet)
	MODBUS TCP/IP (Ethernet)Sub Station
	MODBUS TCP/IP (Ethernet) EXT Format
	MODBUS ASCII
	MODBUS slave (RTU)
	MODBUS slave (TCP/IP)
	MODBUS slave (ASCII)
V-Link	

Temperature Controllers, Servos and Inverters

Maker	Temperature Cotroller/Servo/Inverter
A&D	AD4402 (MODBUS RTU)
	AD4404 (MODBUS RTU)
Agilent	4263 Series
Azbil	SDC10
	SDC15
	SDC20
	SDC21
	SDC25/26
	SDC30/31
	SDC35/36
	SDC45/46
	SDC40A
	SDC40G
	DMC10
	DMC50 (COM)
	AHC2001
	AHC2001+DCP31/32
	DCP31/32
	NX (CPL)
	NX (MODBUS RTU)
NX (MODBUS TCP/IP)	
Banner	Presense PLUS (Ethernet/IP (TCP/IP) )
Bosch Rexroth	IndraDrive
CHINO	LT400 Series (MODBUS RTU)
	DP1000
	DB1000B (MODBUS RTU)
	KR2000 (MODBUS RTU)
	LT230 (MODBUS RTU)
	LT300 (MODBUS RTU)
	LT830 (MODBUS RTU)
DELTA TAU DATA SYSTEMS	PMAC
Fuji Electric	PMAC (Ethernet TCP/IP)
	PYX (MODBUS RTU)
	PXR (MODBUS RTU)
	PXF (MODBUS RTU)
	PXG (MODBUS RTU)
	PXH (MODBUS RTU)
	PUM (MODBUS RTU)
	F-MPC04P (Loader)
	F-MPC Series /FePSU
	FVR-E11S
	FVR-E11S (MODBUS RTU)
	FVR-C11S (MODBUS RTU)
	FRENIC5000G11S/P11S
	FRENIC5000G11S/P11S (MODBUS RTU)
	FRENIC5000VG7S (MODBUS RTU)
	FRENIC-HVAC/AQUA (MODBUS RTU)
	FRENIC-Mini (MODBUS RTU)
	FRENIC-Ace (MODBUS RTU)
	FRENIC-Eco (MODBUS RTU)
	FRENIC-Multi (MODBUS RTU)
	FRENIC MEGA (MODBUS RTU)
	FRENIC MEGA SERVO (MODBUS RTU)
	FRENIC-VG1 (MODBUS RTU)
FRENIC Series (Loader)	
HFR-C9K	
HFR-C11K	
HFR-K1K	
PPMC (MODBUS RTU)	
FALDIC-alpha series	
FALDIC-W series	
PH series	
PHR (MODBUS RTU)	
WA5000	
APR-N (MODBUS RTU)	
ALPHA5 (MODBUS RTU)	
ALPHA5 Smart (MODBUS RTU)	
WE1MA (Ver.A) (MODBUS RTU)	
WE1MA (Ver.B) (MODBUS RTU)	
WSZ series	
WSZ series (Ethernet)	
Gammaflux	TTC2100
Hitachi Industrial Equipment Systems	SJ300 series
	SJ700 series
IAI	X-SEL controller
	ROBO CYLINDER (RCP2/ERC)
	ROBO CYLINDER (RCS/E-CON)
	PCON/ACON/SCON(MODBUS RTU)

Temperature Controllers, Servos and Inverters

Maker	Temperature Cotroller/Servo/Inverter
KOGANEI	IBFL-TC
Lenze	ServoDrive9400 (Ethernet TCP/IP)
	FR-500
MITSUBISHI ELECTRIC	FR-V500
	MR-J2S-A
	MR-J3-A
	MR-J3-T
	FR-E700
MOOG	J124-04x series
M-SYSTEM	R1M series (MODBUS RTU)
OMRON	E5AK
	E5AK-T
	E5AN/E5EN/E5CN/E5GN
	E5AR/E5ER
	E5CK
	E5CK-T
	E5CN-HT
	E5EK
	E5ZD
	E5ZE
	E5ZN
	V600/620/680
	KM20
	KM100
V680S (Ethernet TCP/IP)	
Orientalmotor	High-efficiency AR Series (MODBUS RTU)
	CRK Series (MODBUS RTU)
Panasonic	MINAS A4 Series
	LP-400
RKC	KW Series
	SR-Mini (MODBUS RTU)
	CB100/CB400/CB500/CB700/CB900 (MODBUS RTU)
	SR-Mini (Standard Protocol)
	REX-F400/F700/F900 (Standard Protocol)
	SRV (MODBUS RTU)
	MA900/MA901 (MODBUS RTU)
	SRZ(MODBUS RTU)
FB100/FB400/FB900 (MODBUS RTU)	
RS Automation	CSD5 (MODBUS RTU)
	Moscon-F50 (MODBUS RTU)
SANMEI	Cuty Axis
SanRex	DC AUTO (HKD type)
SHARP	DS-30D
	DS-32D
SHIMADEN	SHIMADEN standard protocol
SHINKO TECHNOS	C Series
	FC Series
	GC Series
	DCL-33A
	JCx-300 Series
	PC-900
	PCD-33A
ACS-13A	
ACD/ACR Series	
WCL-13A	
Siemens	S120 (Ethernet ISOTCP)
SUS	XA-A*
TOHO	TTM-000
	TTM-00BT
	TTM-200 (MODBUS RTU)
TOKYO CHOKOKU PRODUCTS	MB3315/1010
TOSHIBA	VF-S7
	VF-S9
	VF-S11
	VF-S15
	VF-A7
	VF-AS1
	VF-P7
	VF-PS1
	VF-FS1
	VF-MB1
	VF-nC1
	VF-nC3
	TOSHIBA MACHINE
ULVAC	G-TRAN series
UNIPULSE	F340A
	F371
	F720A

Maker	Temperature Cotroller/Servo/Inverter
UNIPULSE	F800
	F805A
YAMAHA	RCX142
Yokogawa Electric	UT100
	UT750
	UT550
	UT520
	UT350
	UT320
	UT2400/2800
	UT450
	UT32A/35A (MODBUS RTU)
	UT52A/55A (MODBUS RTU)
UT75A (MODBUS RTU)	
	μR10000/20000 (Ethernet TCP/IP)
Others	MODBUS RTU
	MODBUS TCP/IP (Ethernet)